



MATHS

NCERT - NCERT Maths(Telugu)

CO-ORDINATE GEOMETRY

Example

1. State the abscissa and ordinate of the following points and describe the position of each point (i) $P(8,8)$ (ii) $Q(6,-8)$.



Watch Video Solution

2. Write the coordinates of the points marked in the

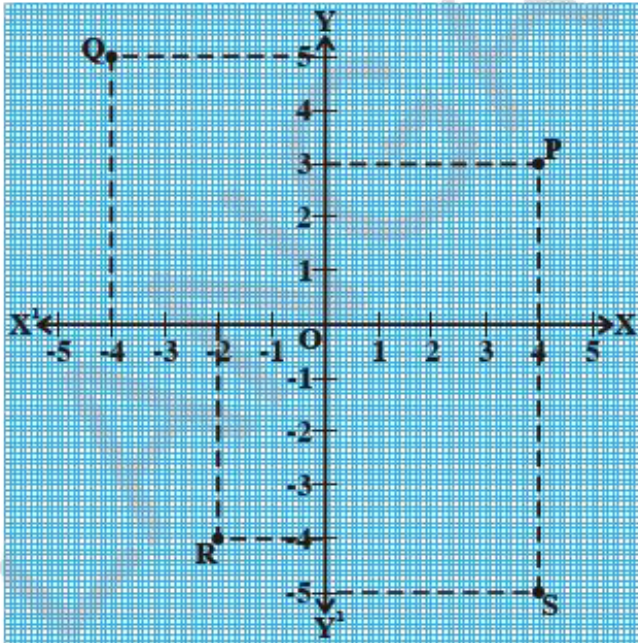

graph.



[Watch Video Solution](#)

3. Write the coordinates of the points marked in the

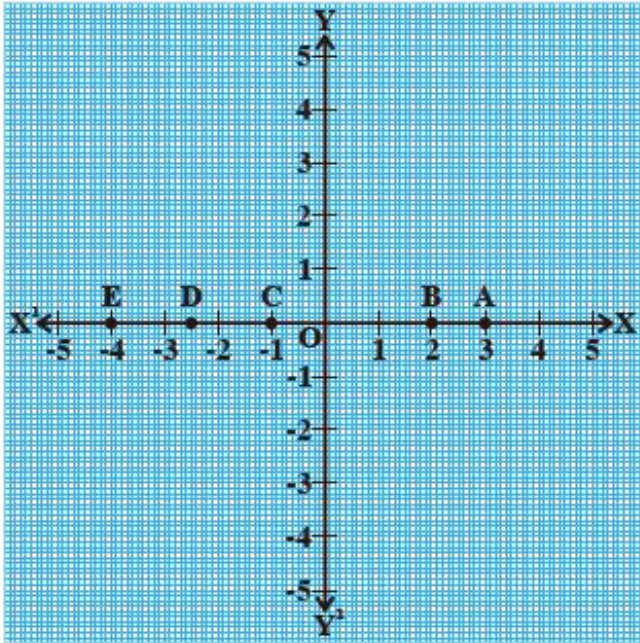

graph.



[Watch Video Solution](#)

4. Write the coordinates of the points marked in the

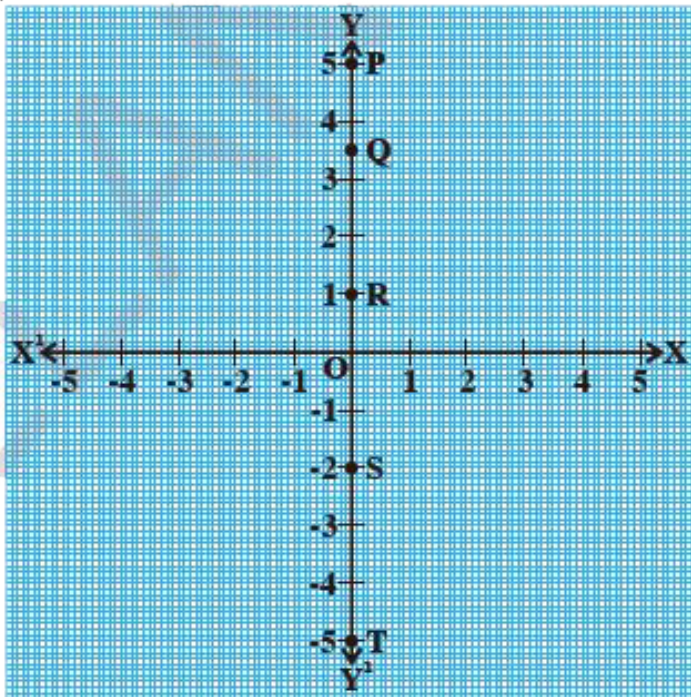

graph.



Watch Video Solution

5. Complete the table based on the following graph.

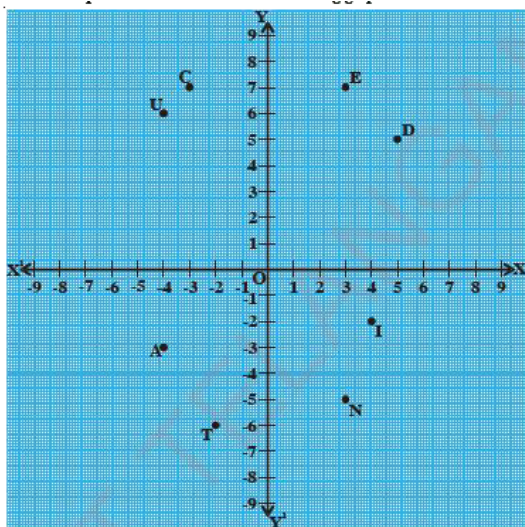

| Point | Abscissa | Ordinate | Co-ordinates | Quadrant | Signs of co-ordinates |
|-------|----------|----------|--------------|----------|-----------------------|
| E | 3 | 7 | E (3,7) | Q_1 | (+, +) |
| D | | | | | |
| U | -4 | 6 | U (-4,6) | | (-,+) |
| C | | | | | |
| A | -4 | -3 | A (-4,-3) | | (-,-) |
| T | | | | | |
| I | 4 | -2 | I (4,-2) | | (+,-) |
| O | | | | | |
| N | | | | | |



Watch Video Solution

6. Plot the following points on a Cartesian plane.

(i) B(-2,3) (ii) L(5,-8) (iii) U(6,4) (iv) E(-3,-3)



[Watch Video Solution](#)

7. Plot the points T(4,-2) and V(-2,4) on a cartesian plane. Whether these two coordinates locate the same point?



[Watch Video Solution](#)

8. Plot the points A(2,2) B(6,2), C(8,5) and D(4,5) in a graph sheet. Join all the points to make it is a

parallalogram. Find its area.



[Watch Video Solution](#)

9. State the abscissa and ordinate of the following point and describe the position of each point

$P(8,8)$



[Watch Video Solution](#)

10. State the abscissa and ordinate of the following point and describe the position of each point

$Q(6, - 8)$



11. Write the coordinates of the points marked in the

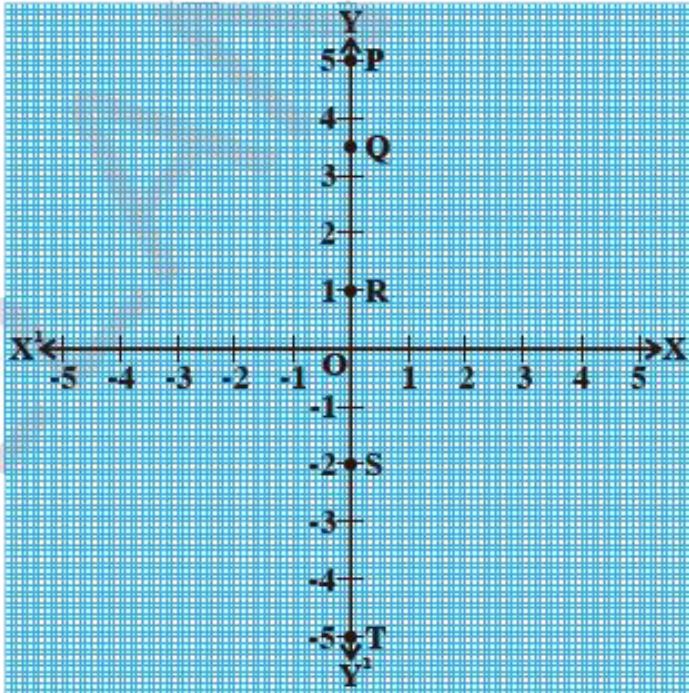

graph.

12. Write the coordinates of the points marked in the graph.



Watch Video Solution

13. Write the coordinates of the points marked in the graph.



Watch Video Solution

14. Complete the table based on the following graph.

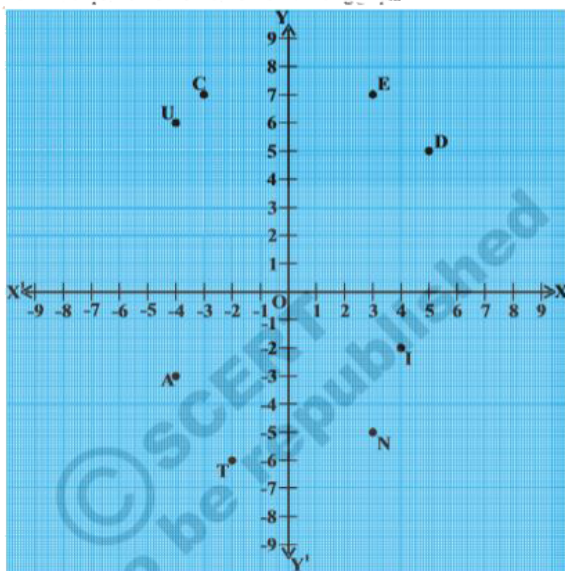

| Point | Abscissa | Ordinate | Co-ordinates | Quadrant | Signs of co-ordinates |
|-------|----------|----------|--------------|----------|-----------------------|
| E | 3 | 7 | E(3,7) | Q_1 | (+, +) |
| D | | | | | |
| U | -4 | 6 | U(-4,6) | | (-, +) |
| C | | | | | |
| A | -4 | -3 | A(-4,-3) | | (-, -) |
| T | | | | | |
| I | 4 | -2 | I(4,-2) | | (+, -) |
| O | | | | | |
| N | | | | | |



Watch Video Solution

15. Plot the following points in the Cartesian plane

$$M(-2, 4)$$



[Watch Video Solution](#)

16. Plot the following points in the Cartesian plane

$$A(-5, -3)$$



[Watch Video Solution](#)

17. Plot the following points in the Cartesian plane

$$N(1, -6)$$



[Watch Video Solution](#)

18. Plot the points $T(4,-2)$ and $V(-2,4)$ on a cartesian plane. Whether these two coordinates locate the same point?



Watch Video Solution

19. Plot the points $A(2,2)$ $B(6,2)$, $C(8,5)$ and $D(4,5)$ in a graph sheet. Join all the points to make it is a parallalogram. Find its area.



Watch Video Solution

20. State the abscissa and ordinate of the following points and describe the position of each point (i) $P(8,8)$ (ii) $Q(6,-8)$.



Watch Video Solution

21. Write the coordinates of the points marked in the

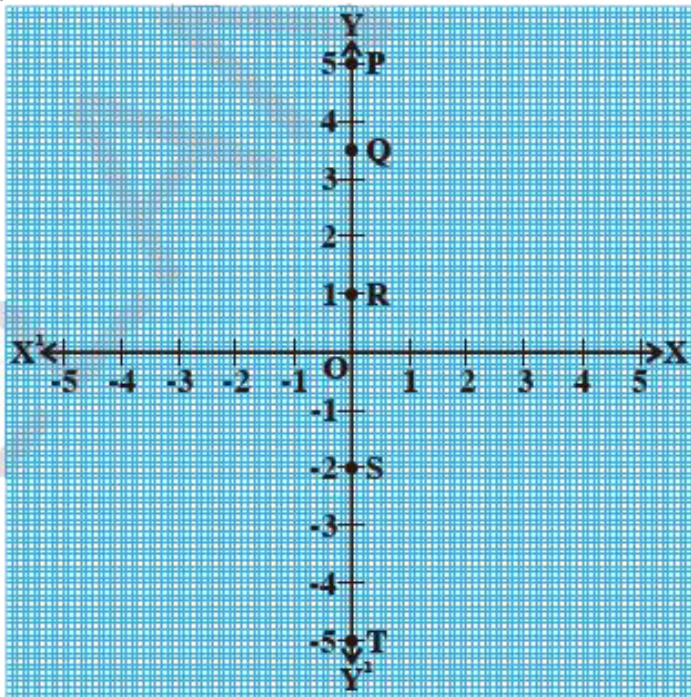

graph.



Watch Video Solution

22. Write the coordinates of the points marked in the graph.

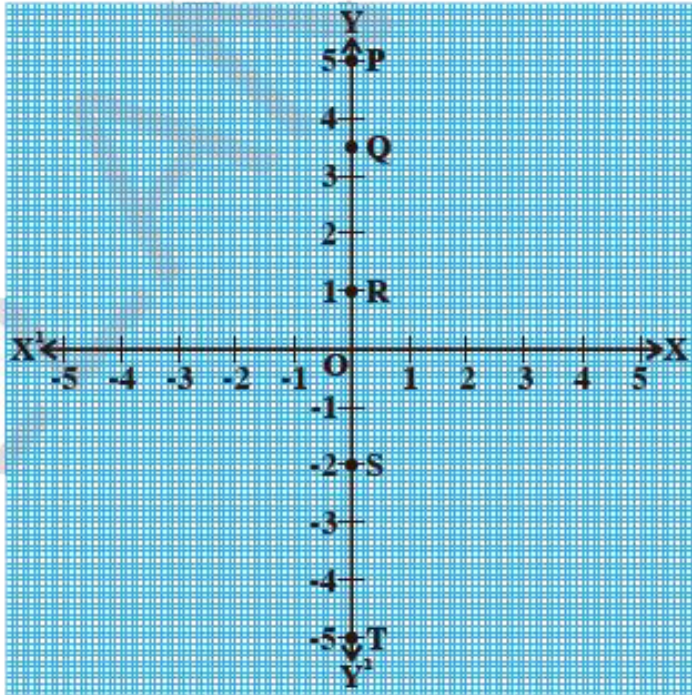

Watch Video Solution

23. Write the coordinates of the points marked in the graph.

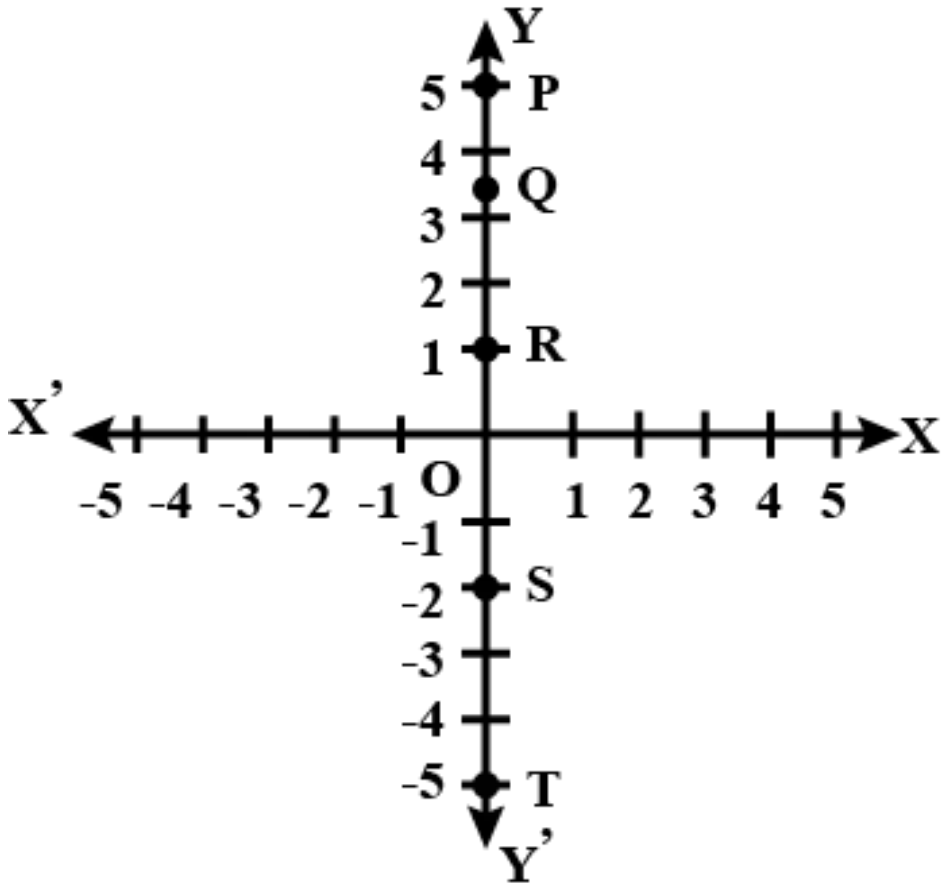

 Watch Video Solution

24. Complete the table based on the following graph.

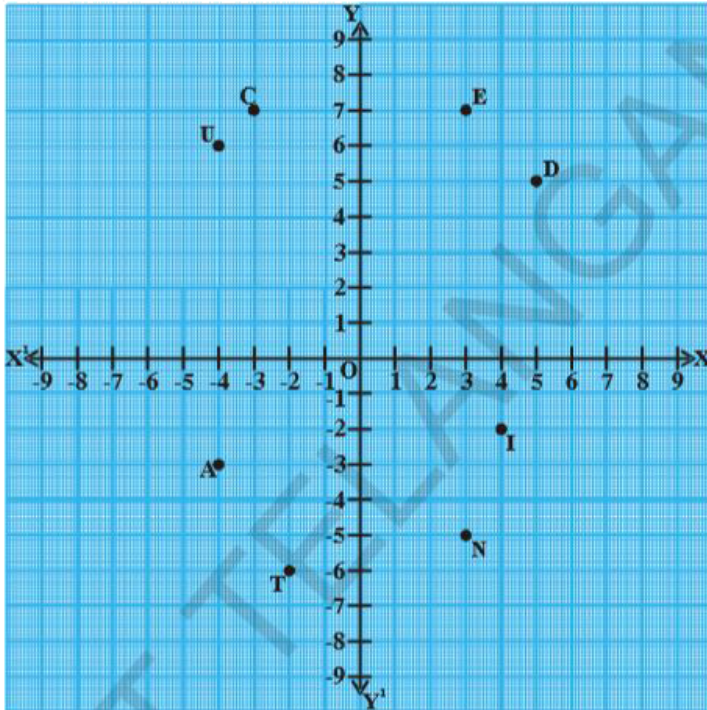

| Point | Abscissa | Ordinate | Co-ordinates | Quadrant | Signs of co-ordinates |
|-------|----------|----------|--------------|----------|-----------------------|
| E | 3 | 7 | E (3,7) | Q_1 | (+, +) |
| D | | | | | |
| U | -4 | 6 | U (-4,6) | | (-,+) |
| C | | | | | |
| A | -4 | -3 | A (-4, -3) | | (-,-) |
| T | | | | | |
| I | 4 | -2 | I (4, -2) | | (+,-) |
| O | | | | | |
| N | | | | | |



Watch Video Solution

25. Plot the following points in the Cartesian plane

$M(-2, 4)$



Watch Video Solution

26. Plot the points $T(4,-2)$ and $V(-2,4)$ on a cartesian plane. Whether these two coordinates locate the same point?



Watch Video Solution

27. Plot the points $A(2,2)$ $B(6,2)$, $C(8,5)$ and $D(4,5)$ in a graph sheet. Join all the points to make it is a parallalogram. Find its area.



Watch Video Solution

1. In a locality, there is a main road along North-South direction.

The map is given below. With the help of the picture answer the following questions.

(i) What is the 3rd object on the left side in street no 3?

(ii) Find the name of the 2nd house which is in right side of street 2.

(iii) Locate the position of Mr. K's house.

(iv) How do you describe the position of the post office.

(v) How do you describe the location of the hospital?

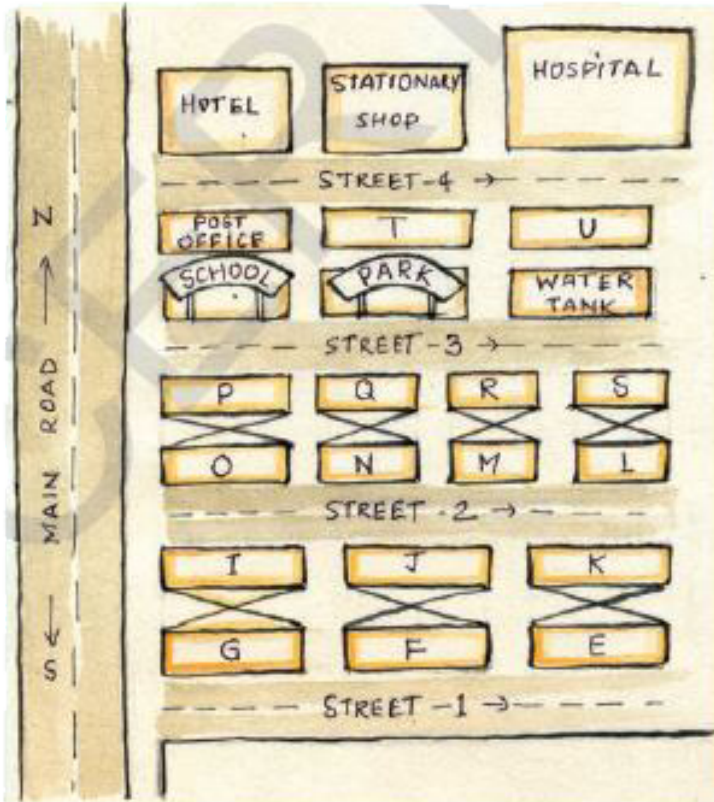

[Watch Video Solution](#)

2. In a locality, there is a main road along North-South direction. The map is given below. With the

help of the picture answer the following questions.

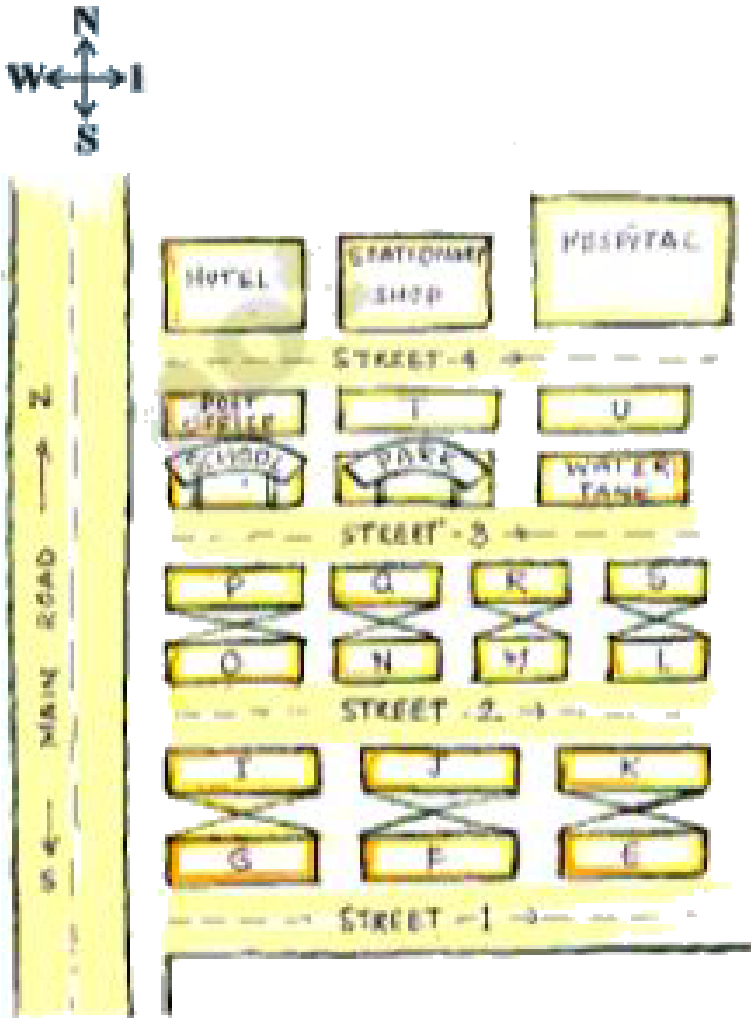

What is the 3rd object on the left side in street no.3?



Watch Video Solution

3. In a locality, there is a main road along North-South direction. The map is given below. With the help of the picture answer the following questions.

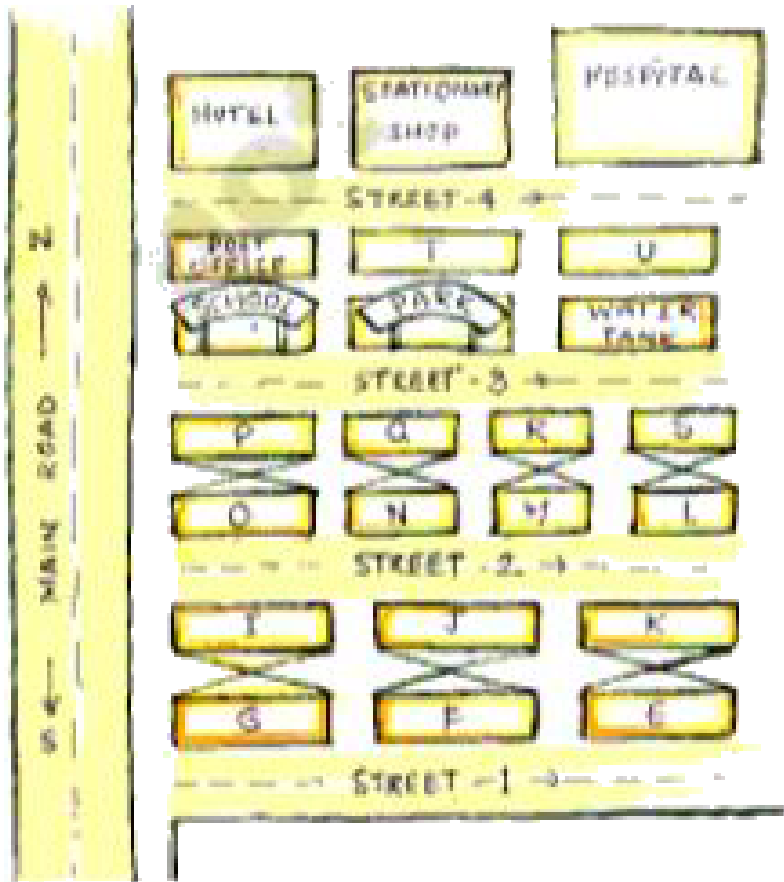

Find the name of the 2nd house which is in right side of street 2.



[Watch Video Solution](#)

4. In a locality, there is a main road along North-South direction. The map is given below. With the help of the picture answer the following questions.

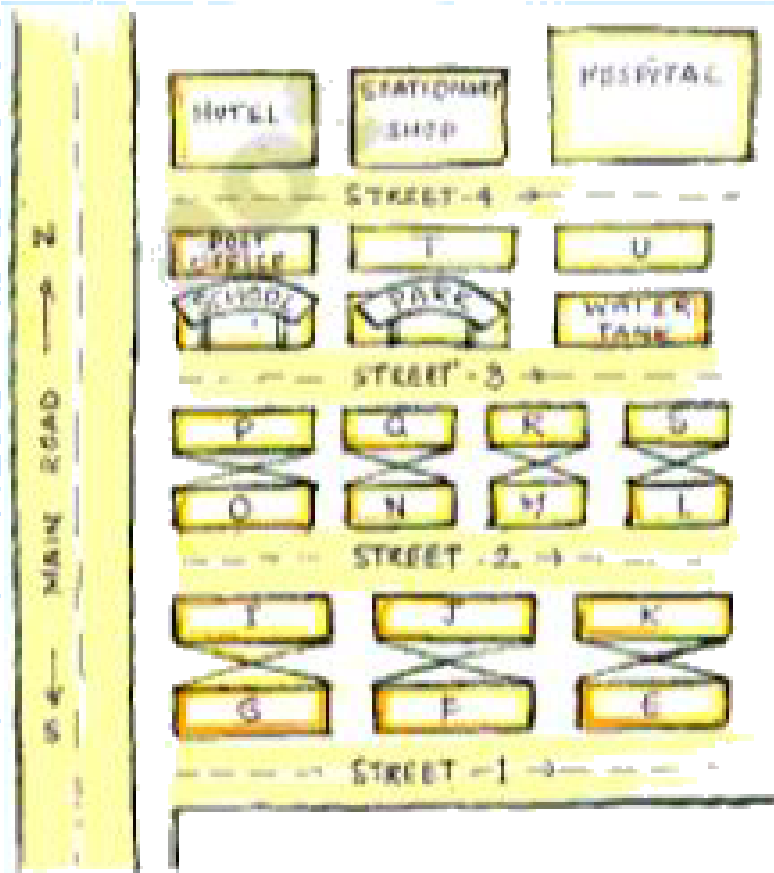

Locate the position of Mr.K's house.

 [Watch Video Solution](#)

5. In a locality, there is a main road along North-South direction. The map is given below. With the help of the picture answer the following questions.

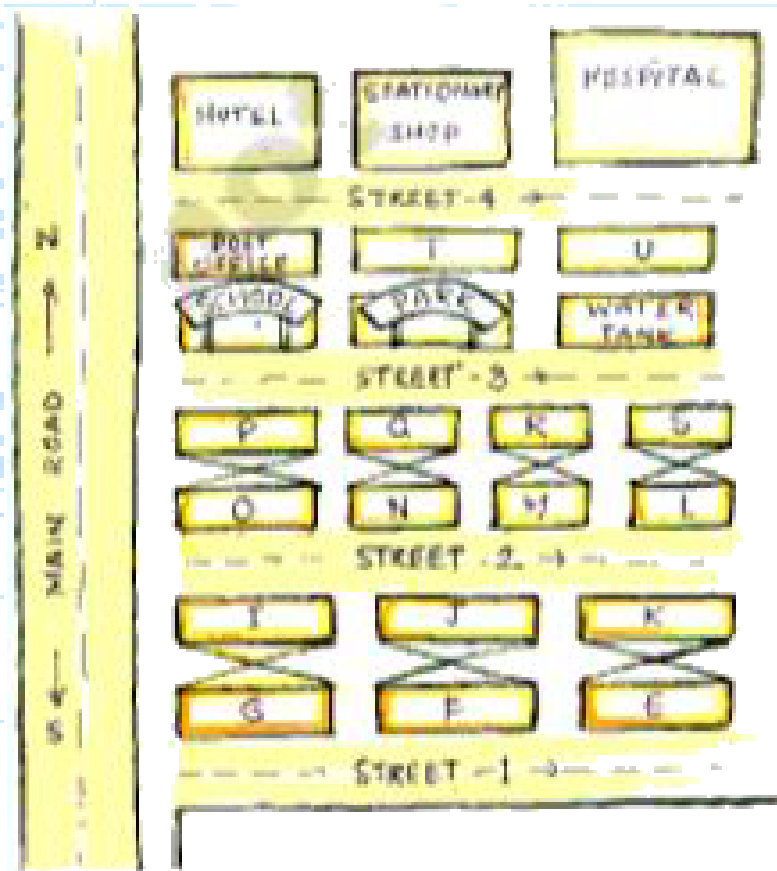

Locate the position of Mr.K's house.



[Watch Video Solution](#)

6. In a locality, there is a main road along North-South direction. The map is given below. With the help of the picture answer the following questions.

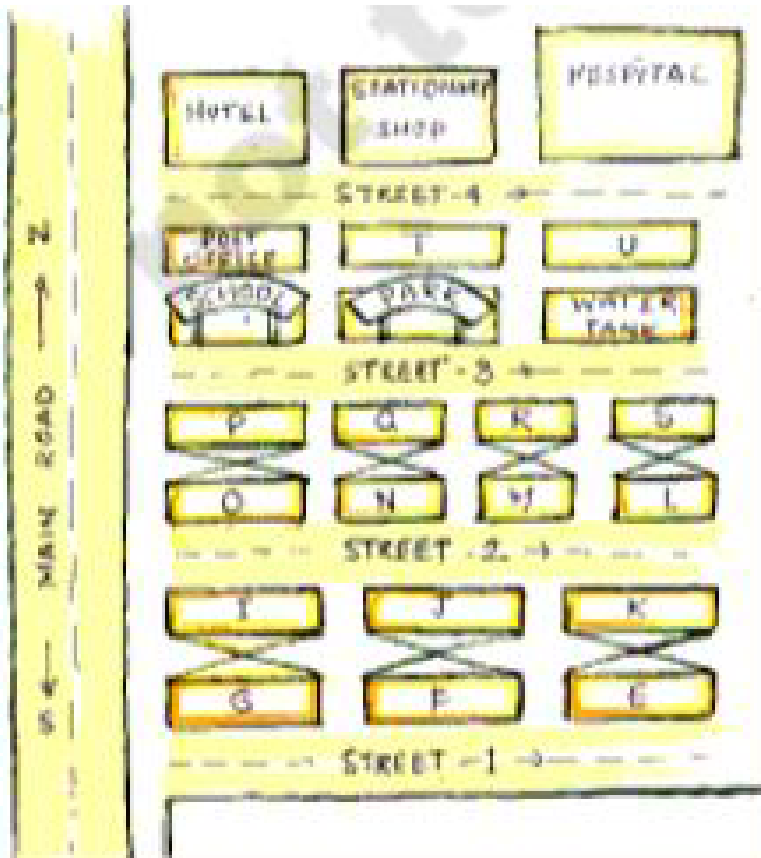

How do you describe the location of the hospital?



Watch Video Solution

7. In a locality, there is a main road along North-South direction.

The map is given below. With the help of the picture answer the following questions.

(i) What is the 3rd object on the left side in street no 3?

(ii) Find the name of the 2nd house which is in right side of street 2.

(iii) Locate the position of Mr. K's house.

(iv) How do you describe the position of the post office.

(v) How do you describe the location of the hospital?

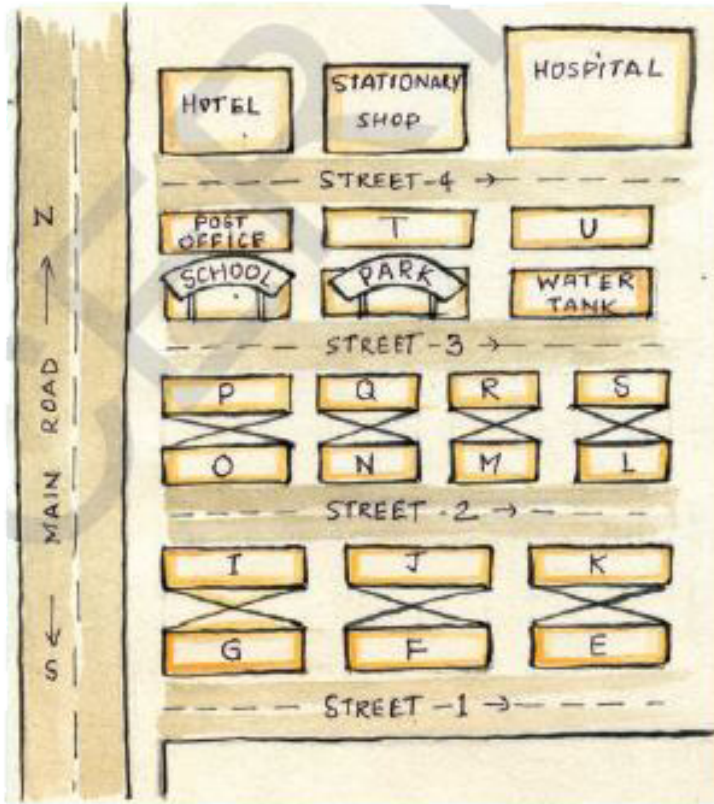

Watch Video Solution

Exercise 5 2

1. Which the quadrant in which of the following points lie?

(i) (-2,3) (ii) (5,-3) (iii) (4,2) (iv) (-7,-6)

(v) (0,8) (vi) (3,0) (vii) (-4,0) (viii) (0,-6)



Watch Video Solution

2. Write the abscissae and ordinates of the following points.

(i) (4,-8) (ii) (-5,3) (iii) (0,0) (iv) (5,0) (v) (0,-8)



Watch Video Solution

3. Which of the following points lie on the axes? Also

name the axis

(i) $(-5,-8)$ (ii) $(0,13)$ (iii) $(4,-2)$ (iv) $(-2,0)$

(v) $(0,-8)$ (vi) $(7,0)$ (vii) $(0,0)$



Watch Video Solution

4. Write the following based on the graph

(i) The ordinate of L

(ii) The ordinate of Q

(iii) The point denoted by $(-2,-2)$

(iv) The point denoted by $(5,-4)$

(v) The abscissa of N

(vi) The abscissa of M

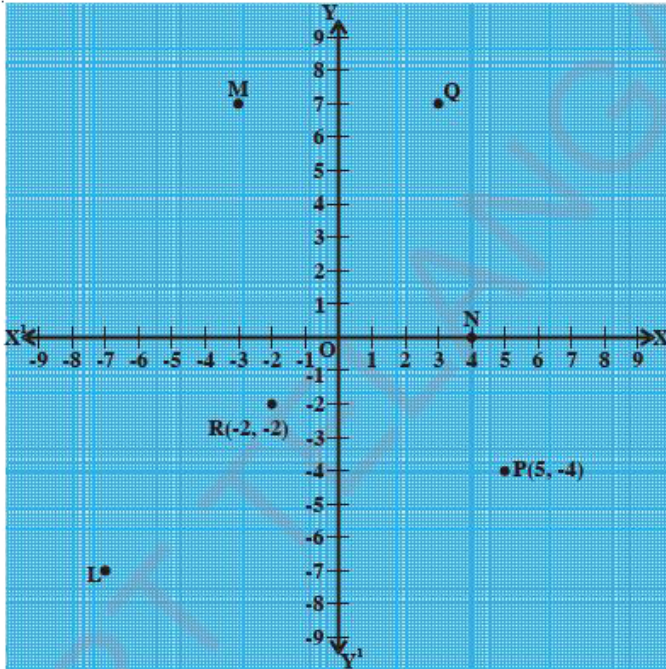

Watch Video Solution

5. State True or False, if 'false' write correct statement.

In the Cartesian plane the horizontal line is called X-axis.



[Watch Video Solution](#)

6. State True or False, if 'false' write correct statement.

In the Cartesian plane the vertical line is called Y-axis.



[Watch Video Solution](#)

7. State True or False, if 'false' write correct statement.

The point which lies on both the axes is called origin.



[Watch Video Solution](#)

8. State True or False, if 'false' write correct statement.

The point $(2,-3)$ lies in the third quadrant.



[Watch Video Solution](#)

9. State True or False, if 'false' write correct statement.

$(-5,-8)$ lies in the fourth quadrant.



[Watch Video Solution](#)

10. State True or False, if 'false' write correct statement.

The point $(-x,-y)$ lies in the first quadrant where $x < 0, y < 0$.



[Watch Video Solution](#)

11. Plot the following ordered pairs on a graph sheet.

What do you observe?

(i) $(1,0)$, $(3,0)$, $(-2,0)$, $(-5,0)$, $(0,0)$, $(5,0)$, $(-6,0)$

(ii) $(0,1)$, $(0,3)$, $(0,-2)$, $(0,-5)$, $(0,0)$, $(0,5)$, $(0,-6)$



[Watch Video Solution](#)

12. Write the quadrant in which the following points

lie?

$(-2, 3)$



[Watch Video Solution](#)

13. Write the quadrant in which the following points lie?

$(5, -3)$



Watch Video Solution

14. Write the quadrant in which the following points lie?

$(4,2)$



Watch Video Solution

15. Write the quadrant in which the following points lie?

$(-7, -6)$



Watch Video Solution

16. Write the quadrant in which the following points lie?

$(0,8)$



Watch Video Solution

17. Write the quadrant in which the following points

lie?

$(3,0)$



[Watch Video Solution](#)

18. Write the quadrant in which the following points

lie?

$(-4, 0)$



[Watch Video Solution](#)

19. Write the quadrant in which the following points lie?

$(0, -6)$



Watch Video Solution

20. Write the abscissae and ordinates of the following points.

$(4, -8)$

Note: Plural of abscissa is abscissae.



Watch Video Solution

21. Write the abscissae and ordinates of the following points.

$(-5, 3)$

Note: Plural of abscissa is abscissae.



Watch Video Solution

22. Write the abscissae and ordinates of the following points.

$(0,0)$

Note: Plural of abscissa is abscissae.



Watch Video Solution

23. Write the abscissae and ordinates of the following points.

$(5,0)$

Note: Plural of abscissa is abscissae.



[Watch Video Solution](#)

24. Write the abscissae and ordinates of the following points.

$(0, - 8)$

Note: Plural of abscissa is abscissae.



[Watch Video Solution](#)

25. Which of the following points lie on the axes?

Also name the axis.

$(-5, -8)$



Watch Video Solution

26. Which of the following points lie on the axes?

Also name the axis.

$(0, 13)$



Watch Video Solution

27. Which of the following points lie on the axes?

Also name the axis.

$(4, -2)$



Watch Video Solution

28. Which of the following points lie on the axes?

Also name the axis.

$(-2, 0)$



Watch Video Solution

29. Which of the following points lie on the axes?

Also name the axis.

$(0, -8)$



Watch Video Solution

30. Which of the following points lie on the axes?

Also name the axis.

$(7,0)$



Watch Video Solution

31. Which of the following points lie on the axes?

Also name the axis.

(0,0)



Watch Video Solution

32. Write the following based on the graph.

The ordinate of L

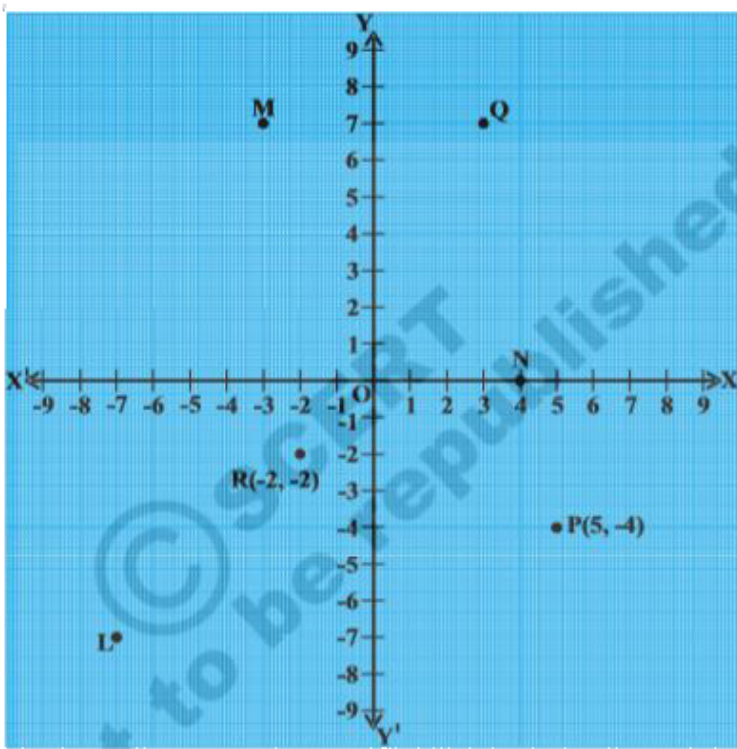

[Watch Video Solution](#)

33. Write the following based on the graph.

The ordinate of Q

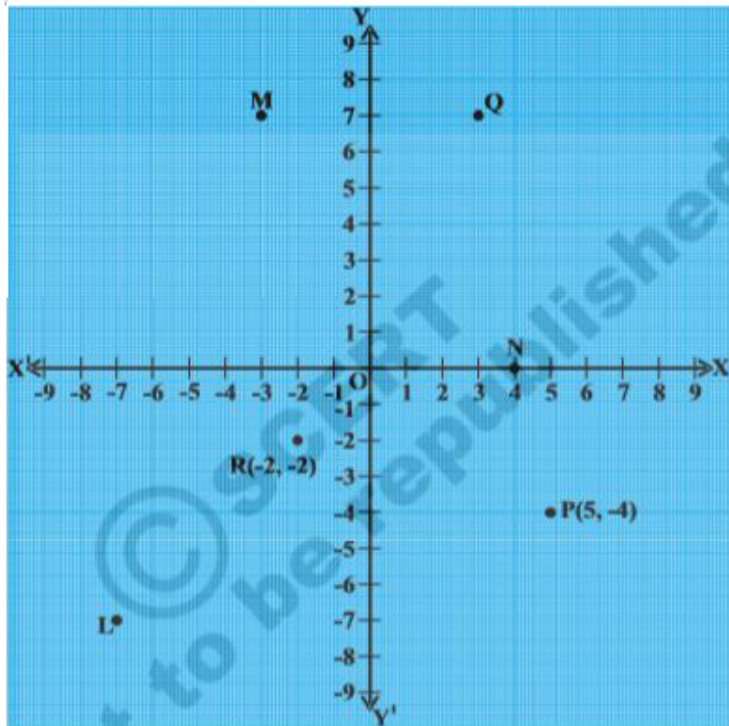

Watch Video Solution

34. Write the following based on the graph.

The point denoted by $(-2, -2)$

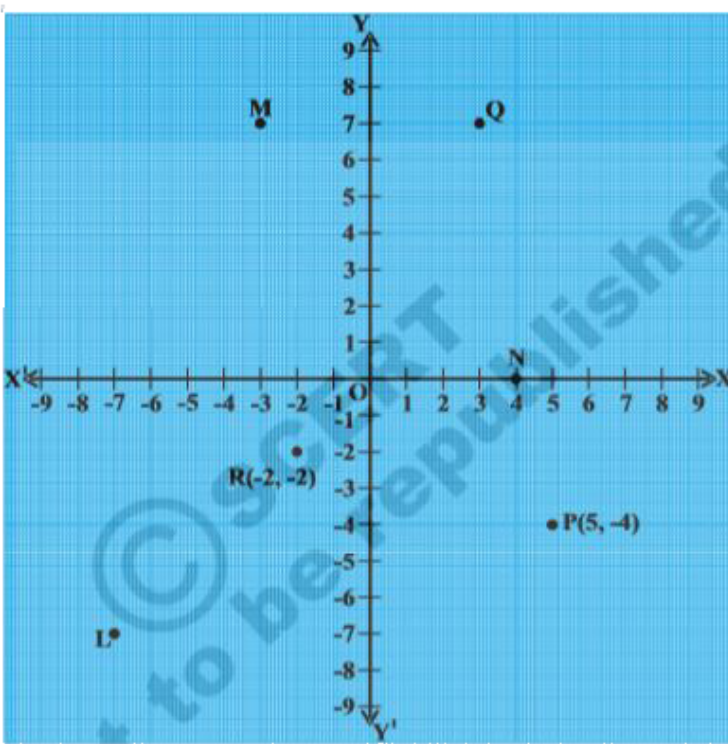

Watch Video Solution

35. Write the following based on the graph.

The point denoted by $(5, -4)$

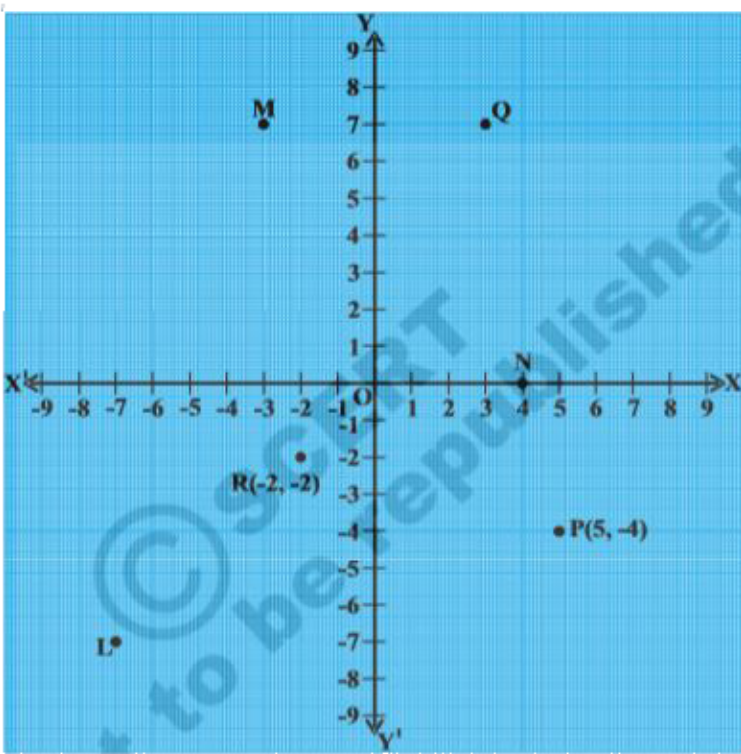

Watch Video Solution

36. Write the following based on the graph.

The abscissa of N

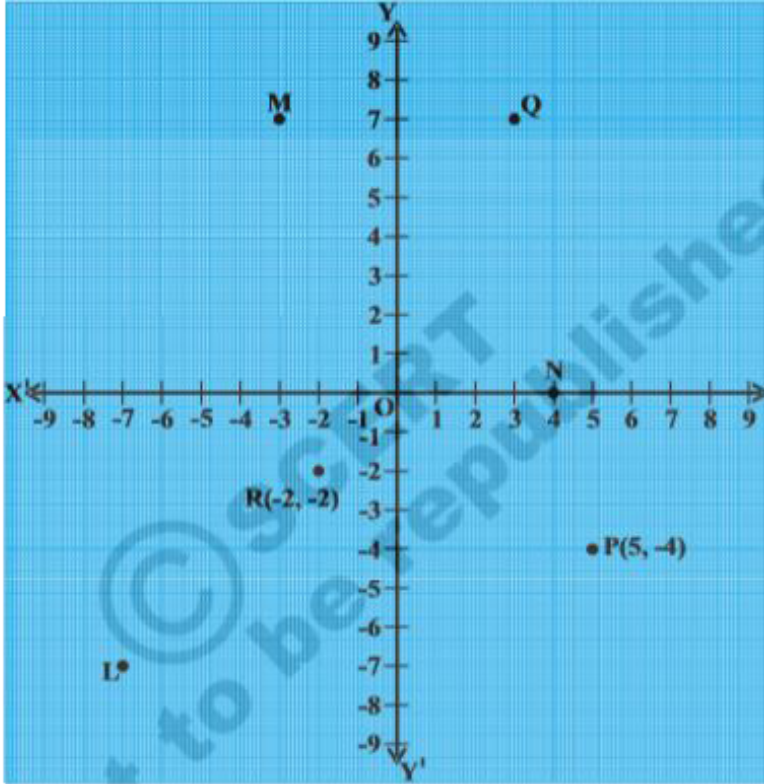

Watch Video Solution

37. Write the following based on the graph.

The abscissa of M

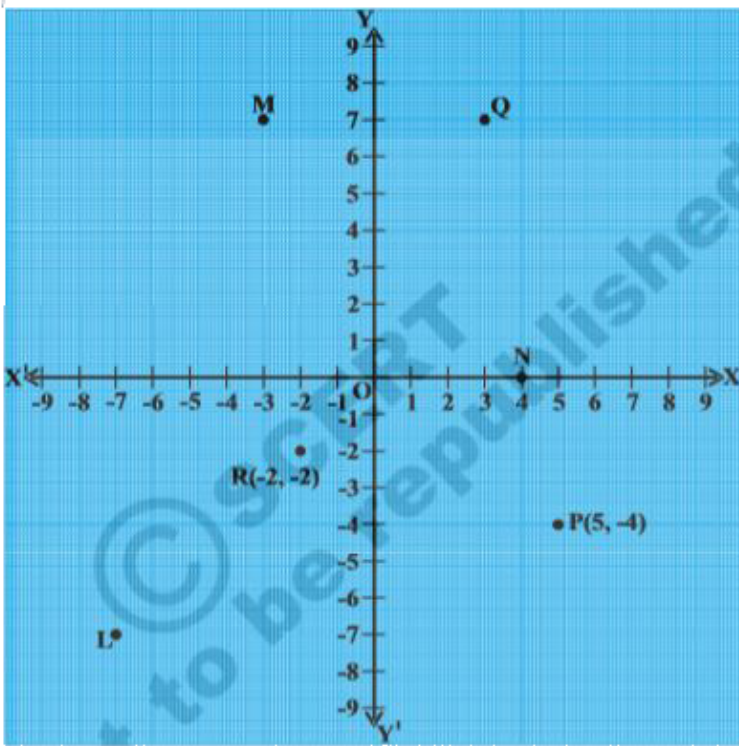

Watch Video Solution

38. State True or False, if 'false' write correct statement.

In the Cartesian plane the horizontal line is called Y-axis.



[Watch Video Solution](#)

39. State True or False, if 'false' write correct statement.

In the Cartesian plane the vertical line is called Y-axis.



[Watch Video Solution](#)

40. State True or False, if 'false' write correct statement.

The point which lies on both the axes is called origin.



Watch Video Solution

41. State True or False, if 'false' write correct statement.

The point $(2,-3)$ lies in the third quadrant.



Watch Video Solution

42. State True or False, if 'false' write correct statement.

$(-5,-8)$ lies in the fourth quadrant.



Watch Video Solution

43. State True or False, if 'false' write correct statement.

The point $(-x,-y)$ lies in the first quadrant where $x < 0, y < 0$.



Watch Video Solution

44. Plot the following ordered pairs on a graph sheet. What do you observe?

$(1, 0)$, $(3, 0)$, $(-2, 0)$, $(-5, 0)$, $(0, 0)$, $(5, 0)$, $(-6, 0)$



Watch Video Solution

45. Plot the following ordered pairs on a graph sheet. What do you observe?

$(0, 1)$, $(0, 3)$, $(0, -2)$, $(0, -5)$, $(0, 0)$, $(0, 5)$, $(0, -6)$



Watch Video Solution

46. Write the quadrant in which the following points lie ?

(i) $(-2, 3)$ (ii) $(5, -3)$ (iii) $(4, 2)$ (iv) $(-7, -6)$

(v) $(0, 8)$ (vi) $(3, 0)$ (vii) $(-4, 0)$ (viii) $(0, -6)$



Watch Video Solution

47. Write the abscissae and ordinates of the following points.

(i) $(4, -8)$ (ii) $(-5, 3)$ (iii) $(0, 0)$ (iv) $(5, 0)$ (v) $(0, -8)$



Watch Video Solution

48. Which of the following points lie on the axes?

Also name the axis

(i) $(-5,-8)$ (ii) $(0,13)$ (iii) $(4,-2)$ (iv) $(-2,0)$

(v) $(0,-8)$ (vi) $(7,0)$ (vii) $(0,0)$



Watch Video Solution

49. Write the following based on the graph

(i) The ordinate of L

(ii) The ordinate of Q

(iii) The point denoted by $(-2,-2)$

(iv) The point denoted by $(5,-4)$

(v) The abscissa of N

(vi) The abscissa of M

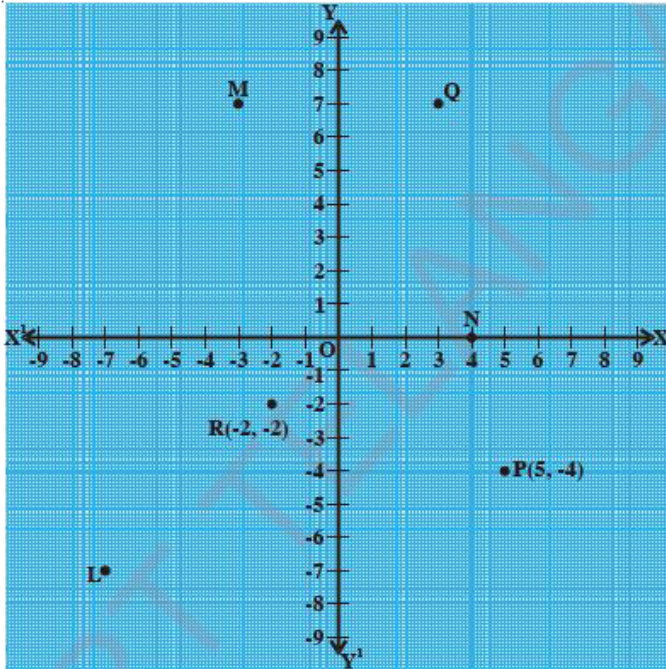

Watch Video Solution

50. State True or False, if 'false' write correct statement.

In the Cartesian plane the horizontal line is called Y-axis.



[Watch Video Solution](#)

51. Plot the following ordered pairs on a graph sheet.

What do you observe?

(i) $(1,0)$, $(3,0)$, $(-2,0)$, $(-5,0)$, $(0,0)$, $(5,0)$, $(-6,0)$

(ii) $(0,1)$, $(0,3)$, $(0,-2)$, $(0,-5)$, $(0,0)$, $(0,5)$, $(0,-6)$



[Watch Video Solution](#)

Exercise 5 3

1. Plot the following in the Cartesian plane whose x,y co-ordinates are given

| | | | | | | |
|--------|----|----|----|----|----|----|
| x | 2 | 3 | -1 | 0 | -9 | -4 |
| y | -3 | -3 | 4 | 11 | 0 | -6 |
| (x, y) | | | | | | |



[Watch Video Solution](#)

2. Are the positions of (5,-8) and (-8,5) is same? Justify your answer.



[Watch Video Solution](#)

3. What can you say about the position of the points $(1,2)$, $(1,3)$, $(1,-4)$, $(1,0)$ and $(1,8)$. Locate on a graph sheet.



[Watch Video Solution](#)

4. What can you say about the position of the points $(5,4)$ $(8,4)$ $(3,4)$, $(0,4)$, $(-4,4)$, $(-2,4)$? Locate the points on a graph sheet. Justify your answer.



[Watch Video Solution](#)

5. Plot the points $(0,0)$, $(0,3)$, $(4,3)$, $(4,0)$ in graph sheet. Join the points with straight lines to make a rectangle. Find the area of the rectangle.



[Watch Video Solution](#)

6. Plot the points $(2,3)$, $(6,3)$ and $(4,7)$ in a graphsheet. Join them to make it a triangle. Find the area of the triangle.



[Watch Video Solution](#)

7. Plot at least six points in a graph sheet, each having the sum of its coordinates equal to 5.



[Watch Video Solution](#)

8. Look at the graph. Write the coordinates of the points A,B,C,D,E,F,G,H,I,J,K,L,M,N,P,O and Q

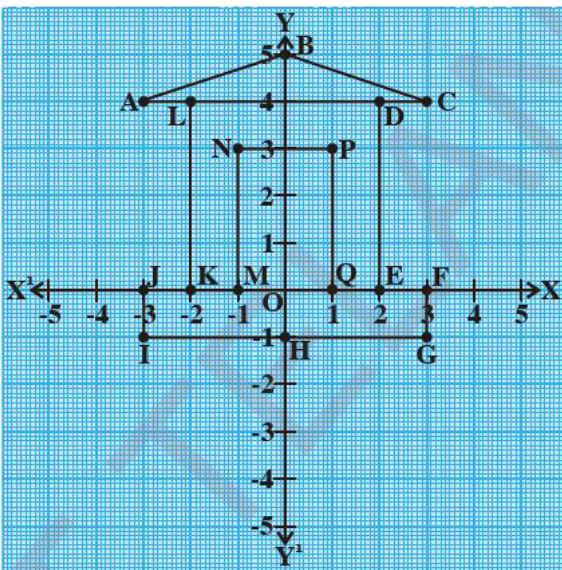



9. ఒక గ్రాఫ్ కాగితంలో కింది క్రమాయుగ్మాల జాతలను బిందువులుగా గుర్తించి, వాటిని రేఖాఖండాల్పై కలపండి. (i) $(2, 5), (4, 7)$ ii) $(-3, 5), (-1, 7)$ iii) $(-3, -4), (2, -4)$ (iv) $(-3, -5), (2, -5)$ v) $(4, -2), (4, -3)$ vi) $(-2, 4), (-2, 3)$ vii) $(-2, 1), (-2, 0)$ అదే గ్రాఫ్ పేపరు పై కింది క్రమాయుగ్మాల జాతాలను బిందువులుగా రేఖకండాల్పై కలపండి. viii) $(-3, 5), (-3, 4)$ ix) $(2, 5), (2, -4)$ x) $(2, -4), (4, -2)$ xi) $(2, -4), (4, -3)$ xii) $(4, -2), (4, 7)$ xiii) $(4, 7), (-1, 7)$ xiv) $(-3, 2), (2, 2)$ అప్పుడు మీరొక ఆశ్చర్యకరమైన పటాన్ని గమనించవచ్చు. అదేమిటి?





Watch Video Solution

10. Plot the following ordered pairs on a graph sheet. What do you observe?

(i) $(1,0)$, $(3,0)$, $(-2,0)$, $(-5,0)$, $(0,0)$, $(5,0)$, $(-6,0)$

(ii) $(0,1)$, $(0,3)$, $(0,-2)$, $(0,-5)$, $(0,0)$, $(0,5)$, $(0,-6)$



Watch Video Solution

11. Plot the following points in the Cartesian plane whose x,y co-ordinates are given.

| | | | | | | |
|---------|----|----|----|----|----|----|
| x | 2 | 3 | -1 | 0 | -9 | -4 |
| y | -3 | -3 | 4 | 11 | 0 | -6 |
| (x,y) | | | | | | |



Watch Video Solution

 [Watch Video Solution](#)

12. Are the positions of $(5,-8)$ and $(-8,5)$ is same?

Justify your answer.

 [Watch Video Solution](#)

13. What can you say about the position of the points $(1,2)$, $(1,3)$, $(1,-4)$, $(1,0)$ and $(1,8)$. Locate on a graph sheet.

 [Watch Video Solution](#)

14. What can you say about the position of the points $(5,4)$ $(8,4)$ $(3,4)$, $(0,4)$, $(-4,4)$, $(-2,4)$? Locate the points on a graph sheet. Justify your answer.



[Watch Video Solution](#)

15. Plot the points $(0,0)$, $(0,3)$, $(4,3)$, $(4,0)$ in graph sheet. Join the points with straight lines to make a rectangle. Find the area of the rectangle.



[Watch Video Solution](#)

16. Plot the points $(2,3)$, $(6,3)$ and $(4,7)$ in a graphsheet. Join them to make it a triangle. Find the area of the triangle.



Watch Video Solution

17. Plot at least six points in a graph sheet, each having the sum of its coordinates equal to 5.



Watch Video Solution

18. Look at the graph. Write the co-ordinates of the points A, B, C, D, E, F, G, H, I, J, K, L, M, N, P, O and Q.

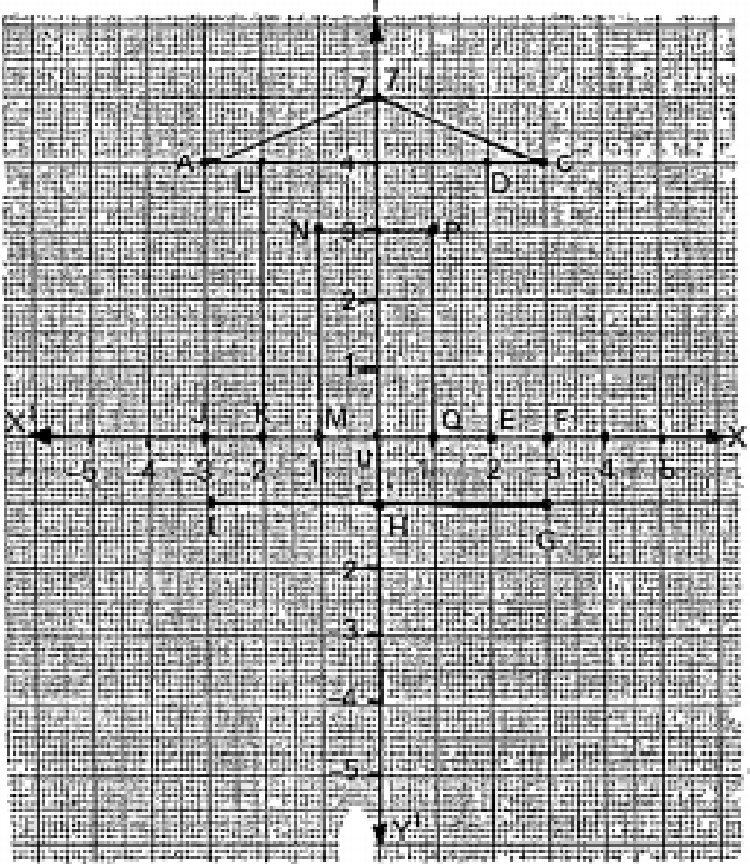

Watch Video Solution

19. In a graph Sheet Plot each pair of points, join them by line segments

- (i) $(2,5)$, $(4,7)$ (ii) $(-3, 5)$, $(-1, 7)$ (iii)
 $(-3, -4)$, $(2, -4)$ (iv) $(-3, -5)$, $(2, -5)$ (v)
 $(4, -2)$, $(4, -3)$ (vi) $(-2, 4)$, $(-2, 3)$ (vii)
 $(-2, 1)$, $(-2, 0)$

Now join the following pairs of points by straight line segments, in the same graph.

- (viii) $(-3, 5)$, $(-3, 4)$ (ix) $(2, 5)$, $(2, -4)$ (x)
 $(2, -4)$, $(4, -2)$ (xi) $(2, -4)$, $(4, -3)$ (xii)
 $(4, -2)$, $(4, 7)$ (xiii) $(4, 7)$, $(-1, 7)$ (xiv)
 $(-3, 2)$, $(2, 2)$

Now you will get a surprise figure. What is it?



Watch Video Solution

20. Plot the following points in the Cartesian plane whose x, y co-ordinates are given.

| | | | | | | |
|----------|----|----|----|----|----|----|
| x | 2 | 3 | -1 | 0 | -9 | -4 |
| y | -3 | -3 | 4 | 11 | 0 | -6 |
| (x, y) | | | | | | |



[Watch Video Solution](#)

21. Are the positions of $(5, -8)$ and $(-8, 5)$ is same?

Justify your answer.



[Watch Video Solution](#)

22. What can you say about the position of the points $(1,2)$, $(1,3)$, $(1,-4)$, $(1,0)$ and $(1,8)$. Locate on a graph sheet.



Watch Video Solution

23. What can you say about the position of the points $(5,4)$ $(8,4)$ $(3,4)$, $(0,4)$, $(-4,4)$, $(-2,4)$? Locate the points on a graph sheet. Justify your answer.



Watch Video Solution

24. Plot the points $(0,0)$, $(0,3)$, $(4,3)$, $(4,0)$ in graph sheet. Join the points with straight lines to make a rectangle. Find the area of the rectangle.



Watch Video Solution

25. Plot the points $(2,3)$, $(6,3)$ and $(4,7)$ in a graphsheet. Join them to make it a triangle. Find the area of the triangle.



Watch Video Solution

26. Plot at least six points in a graph sheet, each having the sum of its coordinates equal to 5.



Watch Video Solution

27. Look at the graph . Write the coordinates of the points A,B,C,D,E,F,G,H,I,J,K,L,L,M,N,P,O and Q.

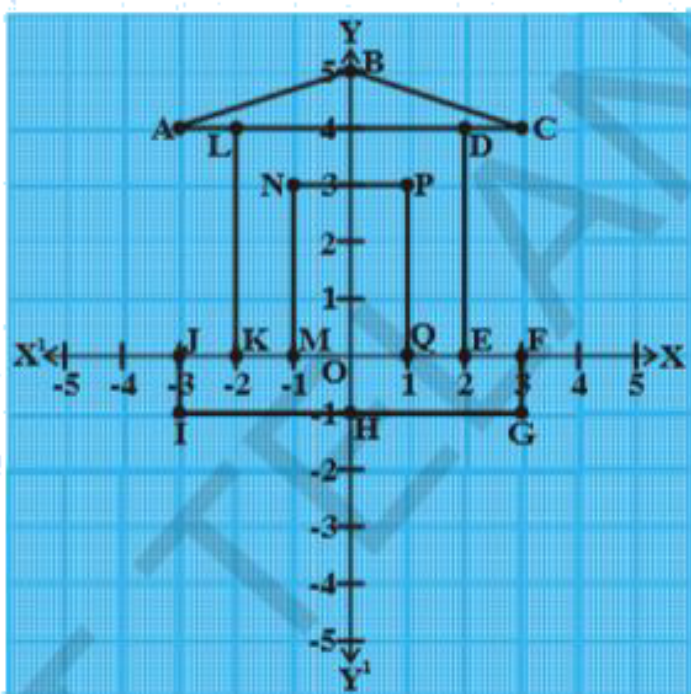

[Watch Video Solution](#)

28. In a graph Sheet Plot each pair of points, join them by line segments

- (i) $(2,5), (4,7)$ (ii) $(-3, 5), (-1, 7)$ (iii)

$(-3, -4), (2, -4)$ (iv) $(-3, -5), (2, -5)$ (v)

$(4, -2), (4, -3)$ (vi) $(-2, 4), (-2, 3)$ (vii)

$(-2, 1), (-2, 0)$

Now join the following pairs of points by straight line segments, in the same graph.

(viii) $(-3, 5), (-3, 4)$ (ix) $(2, 5), (2, -4)$ (x)

$(2, -4), (4, -2)$ (xi) $(2, -4), (4, -3)$ (xii)

$(4, -2), (4, 7)$ (xiii) $(4, 7), (-1, 7)$ (xiv)

$(-3, 2), (2, 2)$

Now you will get a surprise figure. What is it?



Watch Video Solution

29. ఒక గ్రాఫ్ కాగితంపై కింద ఇవ్వబడిన బిందువుల జాతాలను గుర్తించి రేఖ ఖండాలచే కలపండి. $(1, 0)(0, 9)$, $(2, 0)(0, 8)$, $(3, 0)(0, 7)$, $(4, 0)(0, 6)$, $(5, 0)(0, 5)$, $(6, 0)(0, 4)$, $(7, 0)(0, 3)$, $(8, 0)(0, 2)$, $(9, 0)(0, 1)$



[Watch Video Solution](#)

Do This

1. Describe the setting position of any five students in your classroom.



[Watch Video Solution](#)

2. Plot the following points on a Cartesian plane

(i) B(-2,3) (ii) L(5,-8) (iii) U(6,4) (iv) E(-3,-3)



[Watch Video Solution](#)

3. (i) Write the coordinates of the points A,B,C,D,E.

(ii) Write the coordinates of F,G,H,I,J

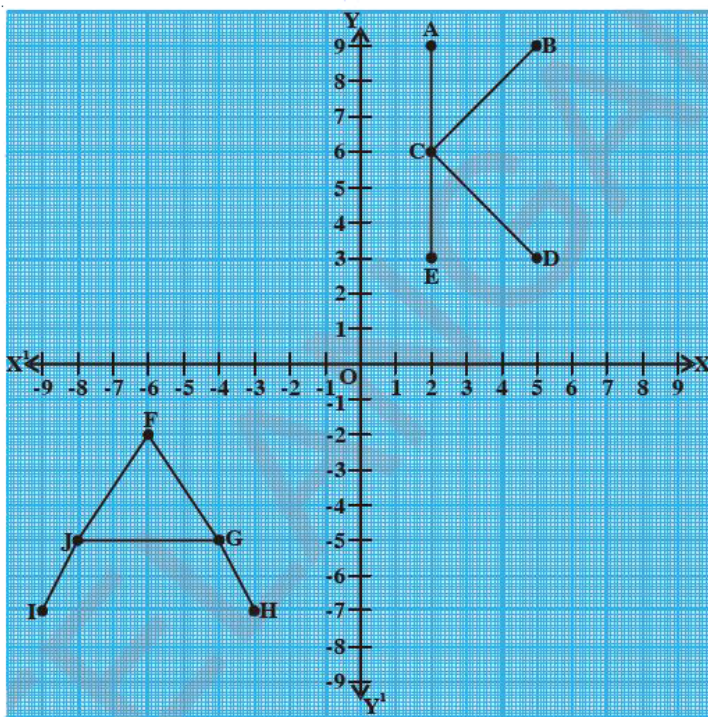

[Watch Video Solution](#)

4. Among the points given below some of the points lie on X-axis. Identify them

(i) (0,5) (ii) (0,0) (iii) (3,0)

(iv) $(-5,0)$ (v) $(-2,-3)$ (vi) $(-6,0)$

(vii) $(0,a)$ (viii) $(b,0)$



Watch Video Solution

5. Describe the setting position of any five students in your classroom.



Watch Video Solution

6. Among the points given below some of the points lie on X-axis. Identify them.

$(0,5)$





[Watch Video Solution](#)

7. Among the points given below some of the points lie on X-axis. Identify them.

$(0,0)$



[Watch Video Solution](#)

8. Among the points given below some of the points lie on X-axis. Identify them.

$(3,0)$



[Watch Video Solution](#)

9. Among the points given below some of the points lie on X-axis. Identify them.

$(-5, 0)$



Watch Video Solution

10. Among the points given below some of the points lie on X-axis. Identify them.

$(-2, -3)$



Watch Video Solution

11. Among the points given below some of the points lie on X-axis. Identify them.

$(-6, 0)$



Watch Video Solution

12. Among the points given below some of the points lie on X-axis. Identify them.

$(0,6)$



Watch Video Solution

13. Among the points given below some of the points lie on X-axis. Identify them.

$(0,a)$



Watch Video Solution

14. Among the points given below some of the points lie on X-axis. Identify them.

$(b,0)$



Watch Video Solution

15. Plot the following points on a Cartesian plane.

$$B(-2, 3)$$



Watch Video Solution

16. Plot the following points on a Cartesian plane.

$$L(5, -8)$$



Watch Video Solution

17. Plot the following points on a Cartesian plane.

$$U(6, 4)$$



Watch Video Solution

 Watch Video Solution

18. Plot the following points on a Cartesian plane.

$$E(-3, -3)$$



Watch Video Solution

19. Write the coordinate of the points A,B,C,D, E

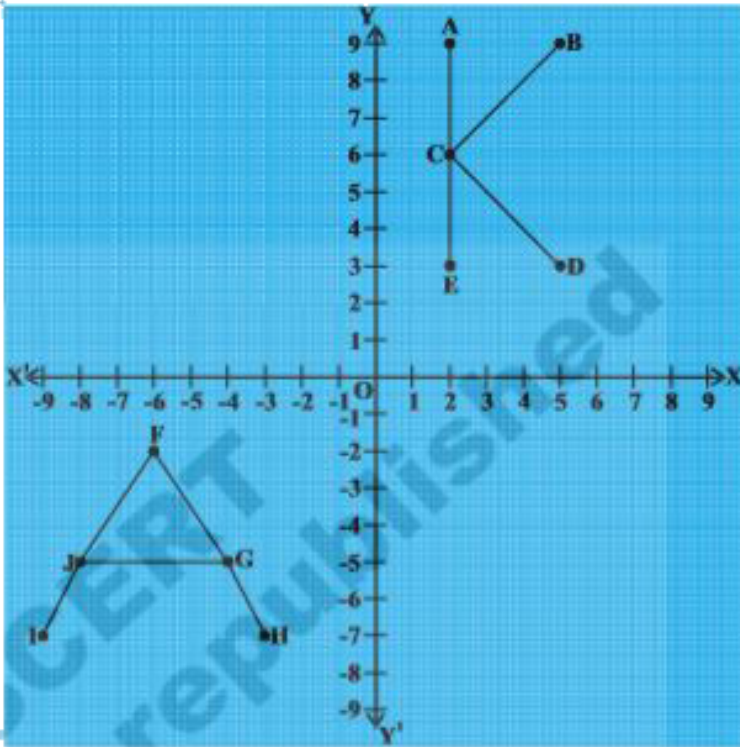

Watch Video Solution

20. Write the coordinates of F,G,H,I,J

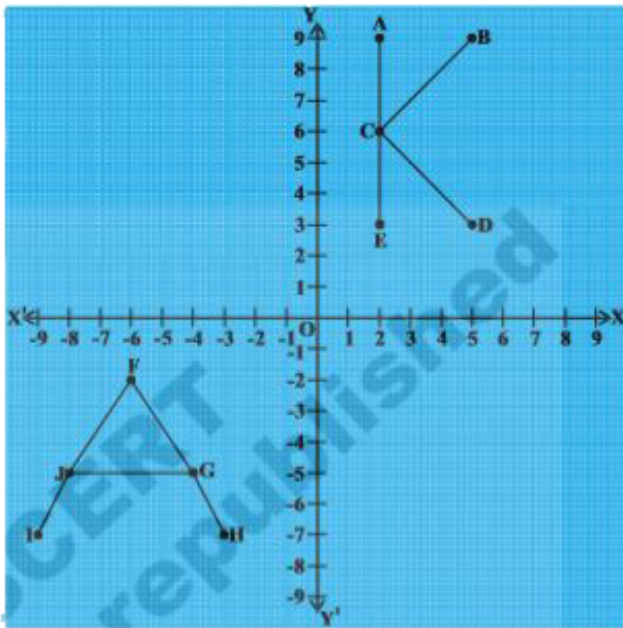

Watch Video Solution

21. Describe the setting position of any five students in your classroom.



[Watch Video Solution](#)

22. Among the points given below some of the points lie on X-axis. Identify them.

(0,5)



[Watch Video Solution](#)

23. Among the points given below some of the points lie on X-axis. Identify them.

(0,0)



[Watch Video Solution](#)

24. Among the points given below some of the points lie on X-axis. Identify them.

$(3,0)$



Watch Video Solution

25. Among the points given below some of the points lie on X-axis. Identify them.

$(-5, 0)$



Watch Video Solution

26. Among the points given below some of the points lie on X-axis . Identify them.

$(- 2, - 3)$



Watch Video Solution

27. Among the points given below some of the points lie on X-axis. Identify them.

$(- 6, 0)$



Watch Video Solution

28. Among the points given below some of the points lie on X-axis. Identify them.

(0,6)



Watch Video Solution

29. Among the points given below some of the points lie on X-axis. Identify them.

(0,a)



Watch Video Solution

30. Among the points given below some of the points lie on X-axis. Identify them.

$(b,0)$



Watch Video Solution

31. Plot the following points on a Cartesian plane.

$B(-2, 3)$



Watch Video Solution

32. Plot the following points on a Cartesian plane.

$L(5,-8)$



[Watch Video Solution](#)

33. Plot the following points on a Cartesian plane.

$U(6,4)$



[Watch Video Solution](#)

34. Plot the following points on a Cartesian plane.

$E(-3, -3)$



[Watch Video Solution](#)

35. Write the coordinates of the points A,B,C, D,E.

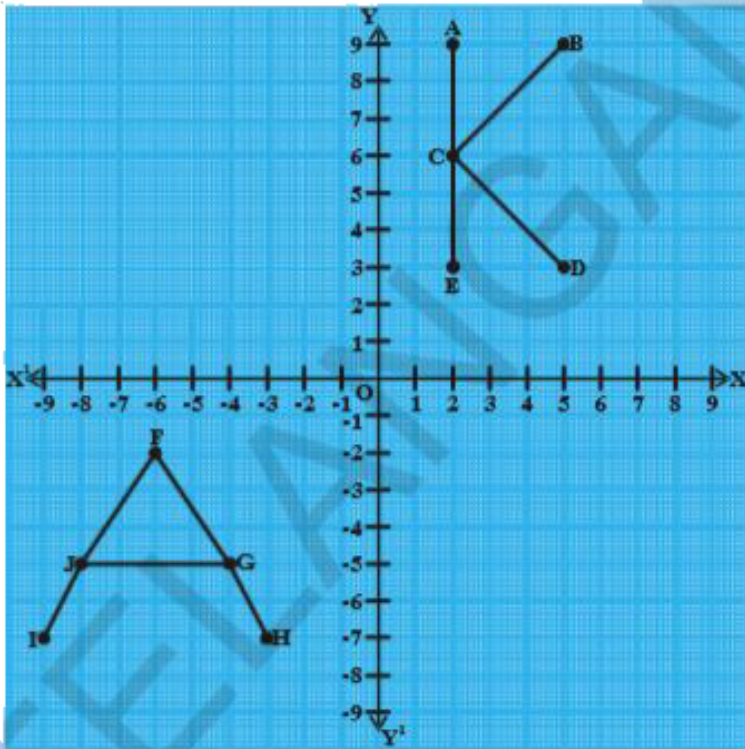

Watch Video Solution

36. Write the coordinates of the points F,G,H,I,J.

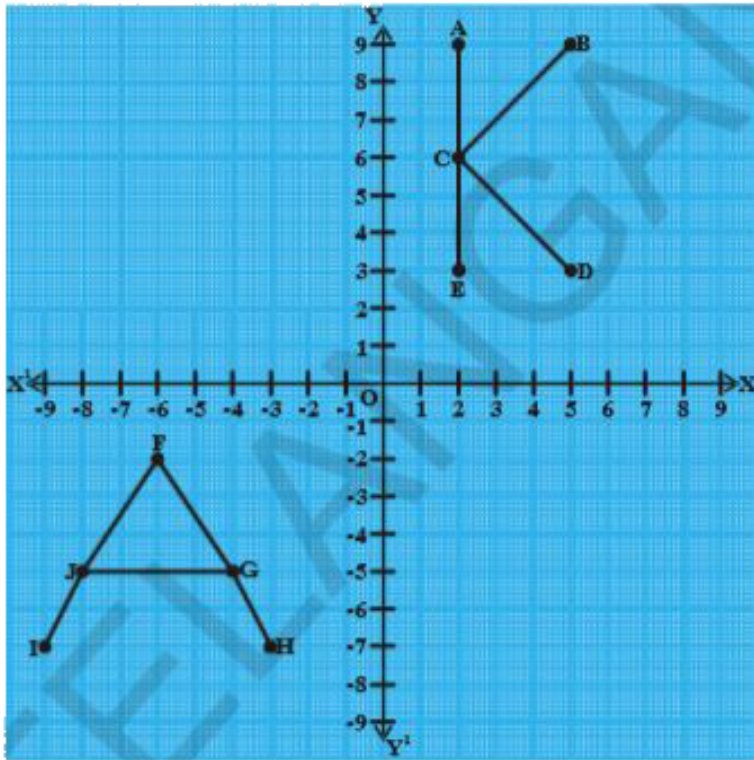

[Watch Video Solution](#)

Try These

1. Which axis the points such as $(0,x)$ $(0,y)$ $(0,2)$ and $(0,-5)$ lie on? Why?



[Watch Video Solution](#)

2. What is the general form of the points which lie on X-axis?



[Watch Video Solution](#)

3. Which axis the points such as $(0,x)$ $(0,y)$ $(0,2)$ and $(0,-5)$ lie on? Why?



[Watch Video Solution](#)

4. What is the general form of the points which lie on X-axis?



[Watch Video Solution](#)

5. Which axis the points such as $(0,x)$ $(0,y)$ $(0,2)$ and $(0,-5)$ lie on? Why?



[Watch Video Solution](#)

6. What is the general form of the points which lie on X-axis ? Write any four points lie on X-axis.



Watch Video Solution